

PERFORMANCE OF ANTI-REFLECTION COATING FOR FIBER LOSS REDUCTION IN FIBER-TO-FIBER CONNECTORS

Ms. Neeru Dahiya
PhD Student
Manav Bharti University
Himachal Pradesh, India

Dr. (BRIG) M.K.Dewan
Director
Saraswati Institute of Engineering & Technology
Ghaziabad, India

Abstract— Connector for optical fibers is a jointing device that ensures efficient coupling between the two fiber ends or two groups of fiber ends, permitting easy manual mating and demating, whenever necessary. The focus of this paper is to reduce the reflection losses by doing an anti-reflection coating of MgF_2 on the connectors. Section 1 comprises of introduction of the connectors. Section 2 is showing the results of the coating, that how the losses are reduced by the help of anti reflection coating of MgF_2 on the connectors in the third window (1350-1650nm).

Keywords— splices, optical connectors, anti reflection coating, reflection losses.

I. INTRODUCTION

SPLICES

Connections are normally quite simple in metallic systems. Wires can be spliced very easily by soldering. The splice can even be undone by melting the solder. Similarly; fiber-to-fiber connections are needed for a variety of reasons. Several fibers must be spliced together for links of more than a few kilometers because only limited continuous lengths of fiber are normally available from manufacturers [8]. Thus, splices are generally permanent fiber joints. So, the problem with the splices is that the two fibers cannot be detached easily and reconnected with the same ease.

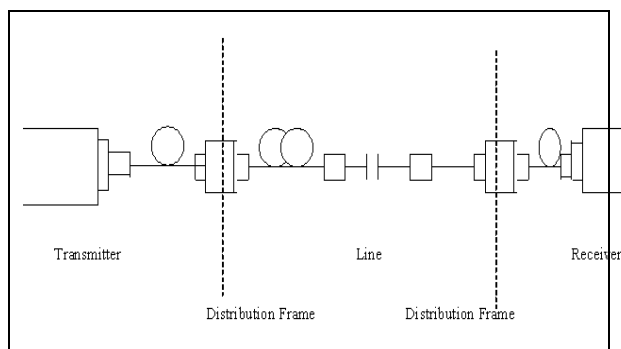

Figure1: Basic diagram of splices & connectors

Also, it is a time consuming process and requires extra efforts. Therefore, the need arises to have fiber-to-fiber connections, which are attachable and detachable when desired. This is what exactly a connector does.

BASIC SPLICING TECHNIQUES:

Basic splicing techniques include fusing the two fibers or bonding them together in an alignment structure. The bond may be provided by an adhesive, by mechanical pressure, or by a combination of the two.

(1) FUSION SPLICING:

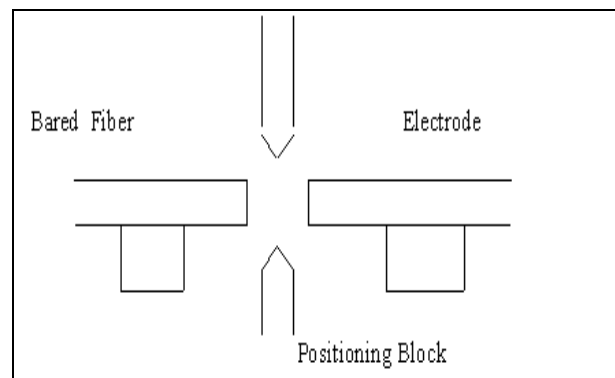

Figure2: Diagram showing electric arc fusion

Fusion splices are produced by welding two glass fibers. Commercial fusion machines use an electric arc to soften the fiber ends. The ends are prepared by the scribe-and-break method. Alignment is obtained by adjusting micromanipulators attached to the fibers [8]. The alignment is visually inspected with a microscope.

(2) ADHESIVE SPLICING:

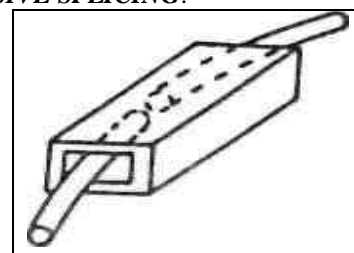

Figure3: Diagram showing the adhesive splicing

A number of alignment configurations have been suggested for splices using adhesive bonding. Each of these structures mechanically aligns the fibers and provides strength to the joint [7]. The fibers are held in place by epoxy. Because the epoxy must be cured, these splices cannot be used immediately. Curing times can be reduced by application of heat or, for some epoxies, exposure to ultraviolet radiation.

(3) ROTARY MECHANICAL SPLICE:

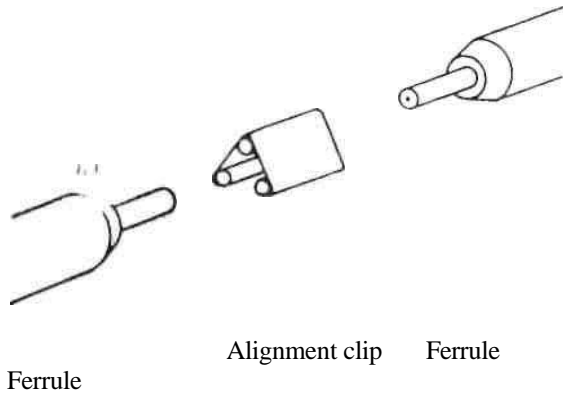

Figure 4: Rotary Mechanical Splice

A splicing technique that does not use a precision-machined structure to align the fibers directly is the rotary mechanical splice. In this splice, three rods in a bronze alignment clip secure the ferrules. The holes in the ferrules are not centered, so that the two fibers can be aligned by rotating the ferrules while monitoring the transmitted power. Since the ferrules are transparent, they can be fixed in place with an UV-curable.

CONNECTORS:

A connector for optical fibers is a jointing device that ensures efficient coupling between the two fiber ends or two groups of fiber ends, permitting easy manual mating and demating, whenever necessary. Permanent splices are typically found along a transmission line, whereas demountable connectors are more likely to be located at a distribution frame and at the transmitter and receiver [5].

Types of Connectors:

- (1) Butt joint connectors
- (2) Multichannel connectors
- (3) Lensed connectors

(1) Butt joint connectors: These connectors consist of a ferrule for each fiber and a precision sleeve into which the ferrules fit. It is of 3 types:

- (a) Straight-sleeve connectors
- (b) Tapered-sleeve connectors
- (c) Overlap connectors

(2) Multichannel Connectors:



Figure 5: Multichannel Connector

Multichannel connectors can be easily constructed. The simplest example is a two-channel connector, which is convenient for duplex systems in which information is carried in one direction in one fiber and in the opposite direction in the second fiber.

The overlap design can accommodate two fibers if it contains sections with two parallel grooves rather than one. The overlap concept could be extended to more than two channels if there were additional grooves [7]. Multichannel connectors may use the straight or tapered-sleeve approaches in what might be called the bayonet style.

(3) Lensed connectors:

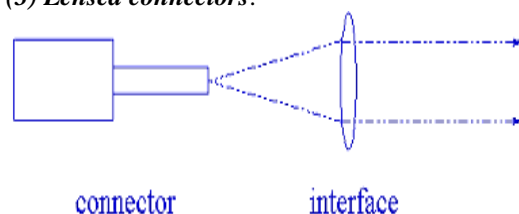

Figure 6: Diagram of Lensed connector

The expanding beam radiating from the transmitting fiber is collimated by a lens. The: fiber-to-lens distance is equal to the focal length, as required for collimation. An identical arrangement exists at the receiver. This configuration is an imaging system with unity magnification, regardless of the spacing between the lenses [6]. The lens separation cannot be arbitrarily large because off-axis rays do not enter the receiving fiber at the same angle that they left the transmitting fiber unless the lens separation is twice the focal length.

LOSSES DUE TO USE OF SPLICES & CONNECTORS:

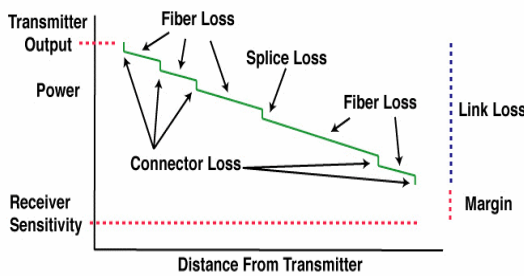

Figure 7: Diagram showing the losses due to the use of splices & connectors

These losses can be reduced by applying the anti-reflection coating of MgF₂ over the connectors [1]. By increasing the number of layers these losses can be reduced further. With the help of simulation tool “C” the results are as follows:-

Formula Used:-

COLLINS FORMULA

It is used to calculate the refractive index of second layer & third layer coating:-

$$n_2/n_1 = [n_s/n_0]^{1/2}$$

where:

- n_s**- Refractive index of substrate
- n₀**- Refractive index of air
- n₁**- Refractive index of first layer

II. SIMULATION RESULTS

GRAPH BETWEEN REFLECTANCE & WAVELENGTH WHEN THERE IS NO COATING:

Range: 800 to 950 nm

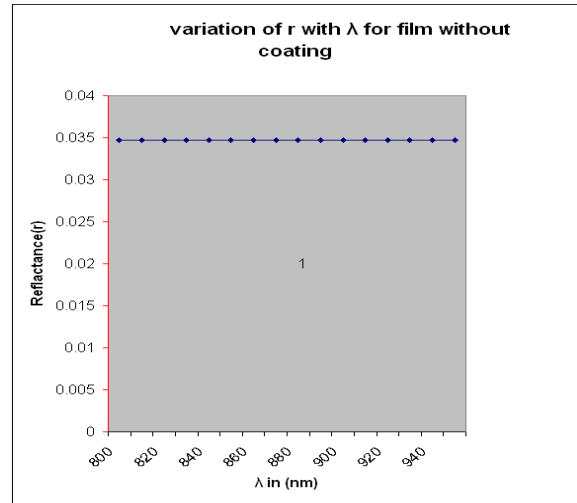

Figure 8: Graph between reflectance and wavelength when there is no coating (800-950nm).

GRAPH BETWEEN REFLECTANCE & WAVELENGTH WHEN THERE IS A SINGLE LAYER COATING OF MgF₂:

Range: 1350 to 1650 nm

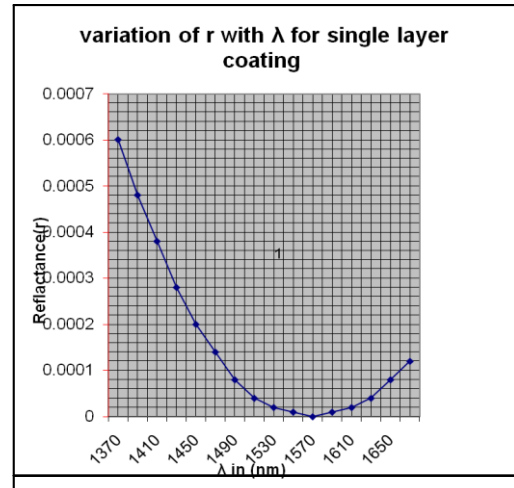

Figure 9: Graph between reflectance and wavelength when there is a single layer coating of MgF₂ (1350-1650nm)

GRAPH BETWEEN REFLECTANCE & WAVELENGTH WHEN THERE IS A TWO LAYER COATING OF MgF₂:

Range: 1350 to 1650 nm

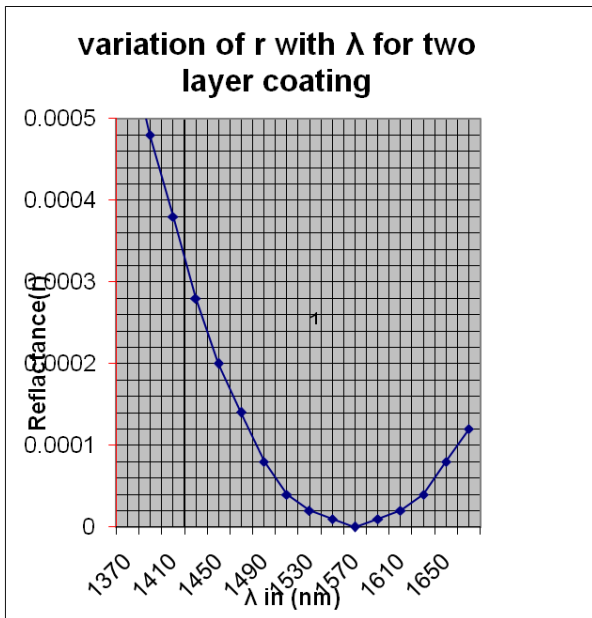

Figure 10: Graph between reflectance and wavelength when there is a two layer coating of MgF₂ (1350-1650nm)

GRAPH BETWEEN REFLECTANCE & WAVELENGTH WHEN THERE IS A THREE LAYER COATING OF MgF₂:

Range: 1350 to 1650 nm

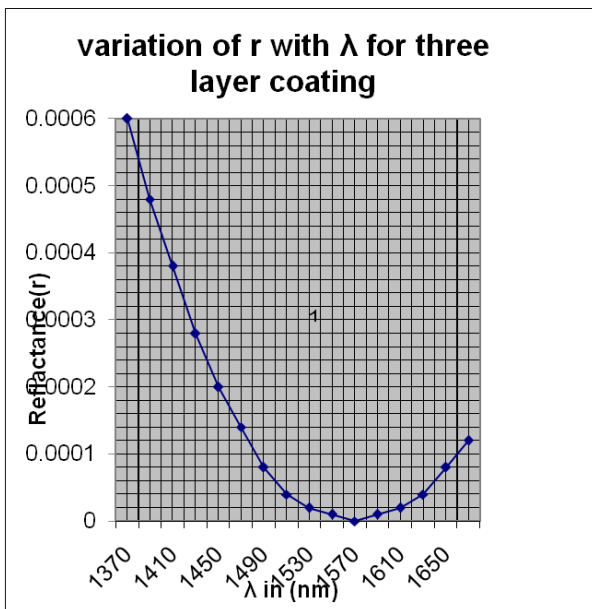

Figure 11: Graph between reflectance and wavelength when there is a three layer coating of MgF₂ (1350-1650nm)

REFERENCES

[1] Alfred H.Thelen, " Design of Coatings on Optical Components", Proceeding of the IEEE, vol. 65, pp. 98-104, June 2005.

[2] Uhlhorn, B.L.; Drexler, G.M.; Nelson, R.L.; Stevens, R.C, "Evaluation of optical connectors for consideration in military avionics", Proceeding of IEEE Conference, vol. 8 , pp. 44-45, Sept.2005.

[3] Yamaguchi, M., "Application of fiber optics for deep-sea exploration systems", Proceedings of IEEE Conference, Volume 15, Issue 3, July 2002.

[4] Hogan, W.K.; Wolf, R.K.; Shukla, A; Deance, P., " Low-cost optical sub-assemblies for metro access applications" Electronic Components and Technology Conference, Volume 1, pp. 1-4, June 2004.

[5] Pimpinella, R.J.; Bergmann, E.E." Optical connectors and variable losses in coupling multimode fibers", Digital Avionics System Conference, 1993. 12th DASC., AIAA/IEEE.

[6] Oh-Gone Chun; Seung-Ho Ahn; Myung-Yung Jeong; Tae-Goo Choy" A study on insertion loss improvement for an optical connector using the analysis of transmitted optical intensity", Components, Hybrids, and Manufacturing Technology, IEEE Transactions, Volume 16, Issue 8, Dec.1993

[7] Lee, K.Y.; Parzygnat, W.J.," Low-reflection, single-mode multifiber array connector", Electronic Components Conference, pp. 362-364, 22-24 May 1989.

[8] Filipenko, A.; Nevludov, I." Control of optical fibers positioning at manufacturing optical connectors and welding splices", Proceedings of the International Conference on Modern Problems of Radio Engineering, Telecommunications and Computer Science, pp. 480-483, 24-28 Feb. 2004

[9] Kanayama, K.; Ando, Y.; Nagase, R.; Iwano, S.; Matsunaga, K.," Advanced physical contact technology for optical connectors" , Proceedings of the IEEE, Volume 4, Issue 11, pp. 1284-1287, Nov. 1992.

[10] Y. Ando, "Statistical analysis of insertion-loss improvement for optical connectors using the orientation method for fiber-core offset", Proc. IEEE, Volume 3, Issue 10, pp. 939-941, Oct.1991.

[11] Asakawa, K.; Shirasaki, Y.," Underwater optical connector for remotely operated submersibles", Proceedings of IEEE Conference, Volume 20, Issue 25, pp. 1031-1032, December 1984.

[12] Neeru Dahiya; Dr. (BRIG) M.K.Dewan,"Reduction of Reflection Losses in fiber-to-fiber connectors", Proceedings of IEEE Conference, 3-4 December 2011.

[13] Neeru Dahiya; Dr. (BRIG) M.K.Dewan,"Analysis of anti-reflection coating for reduction of fiber losses in fiber-to-fiber connectors" Proceedings of IEEE Conference, 24-25 December 2011.